

# User Guide

---

## 48GE+6\*10G SFP+ Managed Switch

This document applies to the 48GE+6\*10G SFP+ Managed Switch. The 48GE+6\*10G SFP+ is used as an example in the product figure unless otherwise specified

## Packing List

When using the Switch for the first time, carefully open the packing box. The packing box should contain the following items:

- Switch \*1
- User manual \*1
- Power cord \*1
- Console line \*1
- Accessories(Hook \*2, Feet \*4, Screw \*8)

 **Note:** Precision devices are built in the device, please handle them carefully to avoid violent vibration, which may affect the performance of the device. If you find that the equipment is damaged or any parts are lost in the process of transportation, please inform us, we will give you a proper solution as soon as possible.

## Chapter 1 Product Introduction

### 1.1 Product Overview

The 48GE+6\*10G SFP+ is a 10Gbps L3 Management Switch independently developed by our company. It has 48\*10/100/1000Mbps RJ45 ports, 6\*10Gbps SFP+ optical module expansion slots, and 1 Console port. Supports static routing, provides complete security policies, QoS policies, and diversified VLAN functions, and is easy to manage and maintain, meeting the networking and access requirements of enterprises, communities, hotels, office networks, and campus networks.

## Chapter 2 Product Appearance Description

### 2.1 Front Panel

The front panel consists of 48\*10/100/1000Mbps adaptive RJ45 ports, 6\*10Gbps SFP slots, 1 Console port and related indicators, as shown in the following figure:

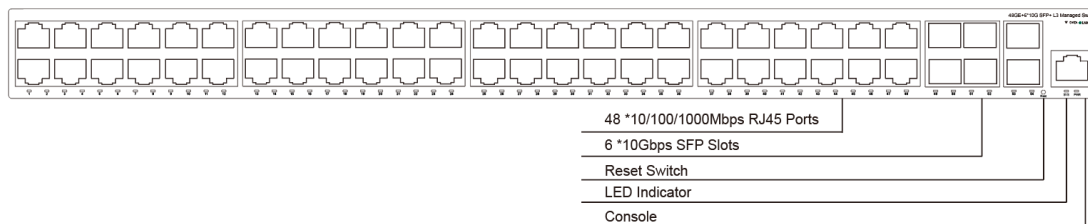

Figure 2-1 Front panel of the 48GE+6\*10G SFP+ Switch

48GE+6\*10G SFP+ Port description:

#### ➤ 10/100/1000Mbps RJ45 Ports

Supports 10Mbps, 100Mbps, or 1000Mbps rate adaptation, auto-MDI /MDIX, and each port has a corresponding indicator, that is, port indicators 1-48 as shown on the panel in the figure above.

#### ➤ 10Gbps SFP Slots

SFP slots are independent SFP slots on the right of the panel. Each port has a corresponding indicator, that is, the indicator 49-54 on the panel in the figure above.

#### ➤ Reset Switch

Reset Switch is simply a Switch that can reset automatically. After long press the reset Switch for 5 seconds, the initial state will be restored when the hand is released.

#### ➤ Console Port

The Console port is used to connect to the serial port of a computer or other terminal device and manage or configure Switches.

#### ➤ LED Indicator

The LED indicator is used to indicate the different working status of the Switch, so that we can check whether the Switch is working properly in time.

## 2.2 LED Indicator

The LED indicators of the Switch are shown in the following table. Users can monitor the work and running status of the Switch conveniently and quickly through the following indicators:

LED	Color	Function
PWR	Green	Off: No Power supply. Light: Indicates the Switch has power.
DATA	Green	Off: No device is connected to the corresponding port. Light: Indicates the link through that port is successfully established at 10/100/1000Mbps. Blink: Indicates that the Switch is actively sending or receiving data over that port.
LNK/ACT	Green	Off: The network is not connected. Steady on: A 10/100/1000Mbps network device is connected. Blinking: Data is being transferred.
SYS	Green	Blinking: The system is working properly Off: The system is being started or is abnormal

## 2.3 Rear panel

The rear panel of a Switch shows the AC power port. The power input ranges from 100 - 240V AC at 50/60 Hz.

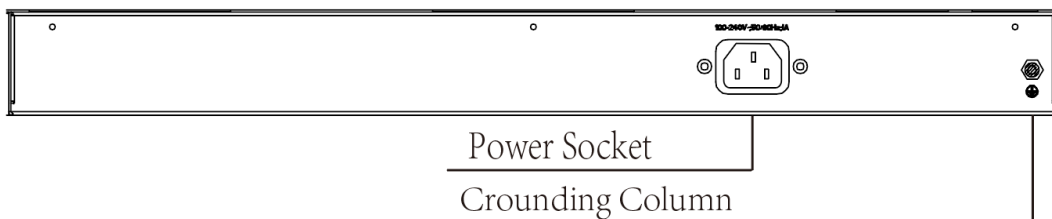

Figure 2-2 Rear panel of the 48GE+6\*10G SFP+ Switch

### AC power port

This is an AC power socket, connect the negative plug of the power cord to this interface, and connect the positive plug to the AC power supply.

### Lightning protection grounding pole

It is located to the left of the power interface. Please use wire grounding to prevent lightning strike.

## Chapter 3 Installation Guide

This chapter helps users correctly install and safely use Switches.

### 3.1 Installation Precautions

 **Precautions:** To avoid equipment damage and personal injury, observe the following precautions:

- The Switch room should be dry and ventilated, free from corrosive gases and strong electromagnetic interference.
- The humidity of the Switch equipment room should be lower than 90%. Install proper devices when possible.
- The grounding of the Switch shall comply with the grounding requirements described in this manual, and shall be separately and well grounded.
- The Switch voltage should be stable to prevent abnormal operation of the Switch caused by power supply voltage mutation, fluctuation and other phenomena;
- Keep a proper distance between the Switch and other devices. Do not stack other devices with the Switch.
- The connection cable between the Switch and the distribution frame should be standardized and reasonable, and the distribution frame (box) jumper wire should be concise and clear to prevent the phenomenon of parallel lines and wires;
- To avoid the danger of electric shock, do not open the chassis without authorization; If any fault occurs, contact professional maintenance personnel.

 **Safety Tips:**

- Use a three-hole socket with safe grounding, and ensure that the PGND cable of the power socket is properly grounded.
- Ensure sufficient space for heat dissipation and ventilation of the Switch. Do not place heavy objects on the Switch.

## 3.2 Installation Environment

Before installation, make sure that the proper working environment is available, including power requirements, adequate space, proximity to other equipment to be connected, and other equipment in place. Please confirm the following installation requirements:

- Ensure the stability of the workbench and good grounding;
- Check whether cables and connectors required for installation are in place (less than 100m).
- The product does not provide installation components. Prepare components of the selected installation type, such as screws, nuts, and tools, to ensure reliable installation.
- Environment requirements: The operating temperature ranges from 0°C to 40°C and the relative humidity ranges from 5% to 90%.

## 3.3 Installation

### Desktop installation

- Place the bottom of the Switch face up on a large enough stable desktop;
- Tear off the attached sticky paper on the surface of the footpad and paste the footpad into the groove at the bottom of the chassis of the Switch to prevent external vibration;
- Carefully position the Switch upright on the workbench;

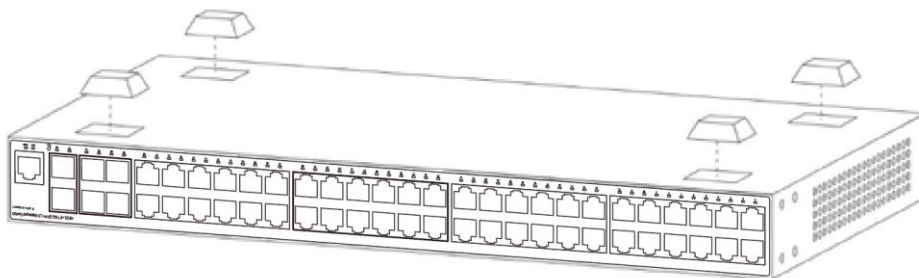

Figure 3 - 1 Desktop Installation Diagram

### Rack mounted

- Check the grounding and stability of the EIA-19inch cabinet;
- Fix mounting ears to both sides of the front panel of the Switch using screws.

Place the Switch on a bracket of the cabinet and move the Switch along the guide rails of the cabinet to a proper position;

- Use screws to fix mounting ears to the guide rails at both ends of the cabinet to ensure that the Switch is securely installed on the brackets in the cabinet slots. The mounting ear of the device is not used for weight bearing, it is only used for fixation;
- When installing devices in a cabinet, brackets (fixed on the cabinet) are provided below the device chassis to support devices.

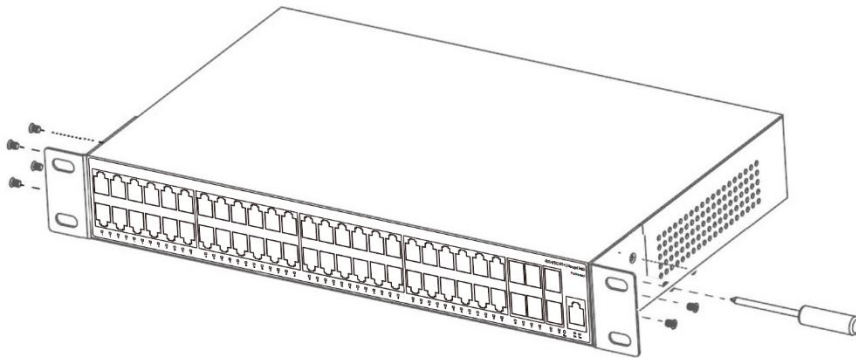

Figure 3-2 Diagram 1 of rack installation

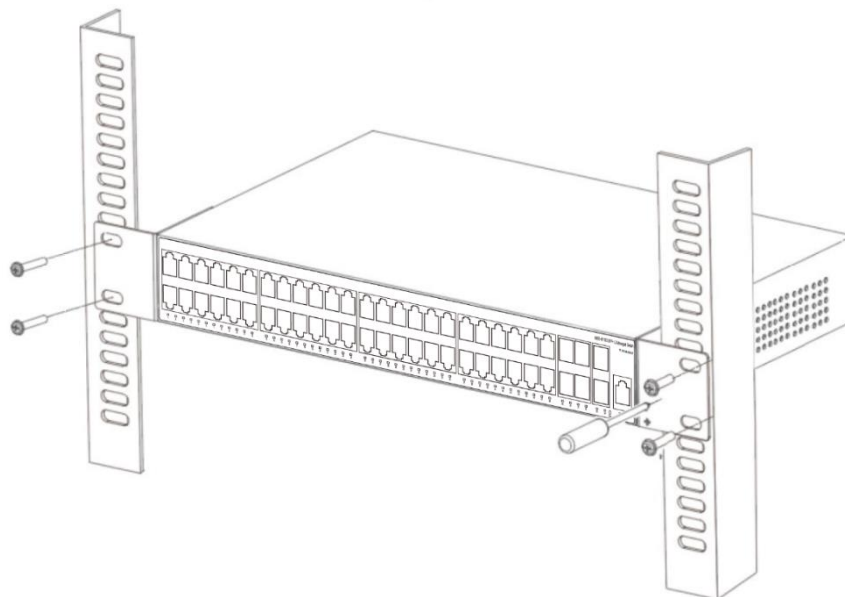

Figure 3-3 Diagram 2 of rack installation

### 3.4 Enabling the Switch

Connect the power cord, plug in, and turn on the power. After the Switch is started, the Switch automatically initializes. If all port indicators are on and off, the system is successfully reset. The power LED indicator is steady on.

**Note:** Before powering on the device, ensure that the voltage is correct; otherwise, the device may be damaged. (Power input range: 100-240V AC 50/60Hz).

## Appendix: Technical Specifications

Model	48GE+6*10G SFP+ Managed Switch
Standard	IEEE 802.3, IEEE 802.3u, IEEE 802.3ab, IEEE 802.3z, IEEE 802.3x, IEEE 802.1X, IEEE 802.1q, IEEE 802.1p, IEEE 802.1d, IEEE 802.1w, IEEE 802.3ad
Network Media(Cable)	10BASE-T: UTP category 3, 4, 5 cable(≤100m) 100BASE-TX: UTP category 5, 5e cable(≤100m) 1000BASE-T: UTP category 5e, 5 cable(≤100m) 1000BASE-X: MMF, SMF 10GBASE-X: MMF, SMF
MAC Address Table	32K, Auto-learning, Auto-aging
Packet Buffer	16Mbit
Transfer Mode	Store-and-Forward
Jumbo Frames	12K Byte
Switching Capacity	216Gbps
Packet Forward Speed	160.71Mpps
Dimensions (L*W*H)	440*260*44mm
Fan	1
Input Voltage	AC 100-240V 50/60Hz
Power Supply	60W
Temperature	Operating Temperature: 0°C ~ 40 °C Storage Temperature: -40 °C ~ 70°C
Humidity	Operating Humidity: 10% ~ 90% non-condensing Storage Humidity: 5% ~ 90% non-condensing