

REMOTE LCD DISPLAY DS User Manual

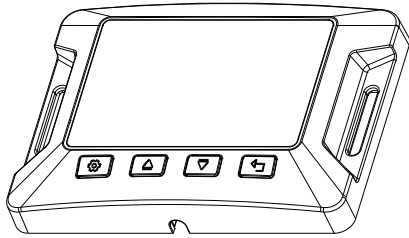

1. Product Features

Thanks for using our product. This LCD display product has been used as the remote display unit for our charge controllers. You can check the working status and parameters in the screen, and set the system working parameters by key press operation.

- a. Exclusive design for PV charge system monitoring
- b. Auto page down for easy viewing
- c. Easy fixture for remote monitoring
- d. With LED indicators to show PV/Battery/Load/Error status.
- e. 4 keys for multiple operation settings
- f. RS485 communication protocol

2. Device Diagram

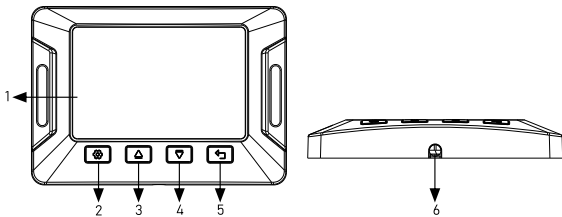

1	LCD Display Screen	4	Key-"DOWN"
2	Key-"SET"	5	Key-"ESC/LOAD"
3	Key-"UP"	6	RS485 Holes

3. Dimensions

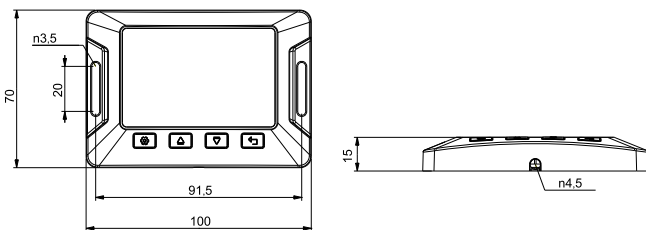

we reserve the rights to modify these specifications without prior notice.

4. RS485 Port RJ12 Instruction

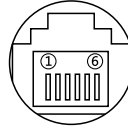

RS485 PIN					
PIN-1	PIN-2	PIN-3	PIN-4	PIN-5	PIN-6
VDD	VDD	GND	GND	D-	D+

5. Installation methods

We provide 2 ways of wiring placement as shown in picture below for different installation uses. The user can either mount the screen directly on the wall, or fix it to the cabinet with wiring extended from the back of the screen.

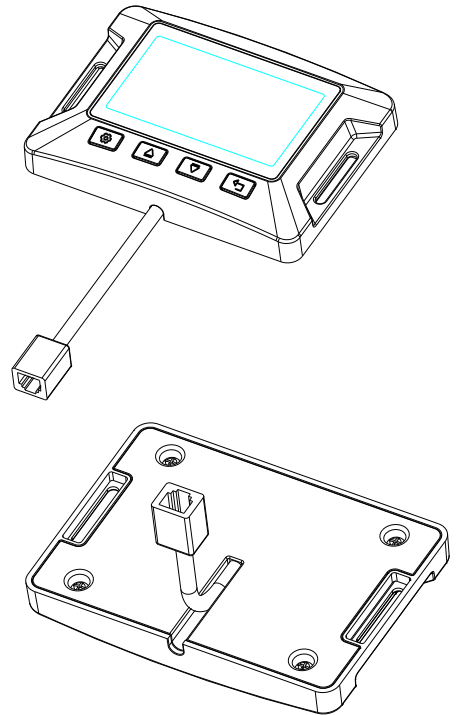

6. LCD Display Instruction

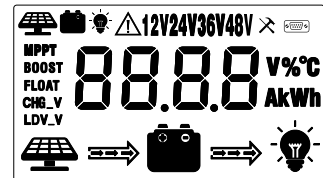

Display Section	Display Layout
Charge Status	\Rightarrow \Rightarrow
Charge Mode & Parameter	88.88 V%°C
Active Functions	Δ 12V24V36V48V \times

7. Display Information Float

Status Icon	Indication	Status	Description
	Solar Charge Indication	Flowing	Solar Power Charging Battery
		Off	Solar Power Not Charging Battery
	DC Load Indication	Flowing	DC Load Drawing Power
		Off	DC Load Off
MPPT	Charge Mode	Steady On	MPPT Charge Mode
BOOST			Boost Charge Mode
FLOAT			Float Charge Mode
		Off	Not Charging
CHG_V	Voltage Setting	On	Setting Charge Voltage
		Off	Charge Voltage Has Been Set
LDV_V	Over Discharge Volt Settings	On	Setting Discharge Voltage
		Off	Discharge Voltage Has Been Set
	Solar Icon	Steady On	Daylight Detected
		Off	No Daylight Detected
		Fast Flash	Solar System Over Voltage
	Battery Icon	Steady On	Battery Connected and Functional
		Off	No Battery Connection
		Fast Flash	Battery Over-Discharged
	Load Status	Flash	DC Load Short Circuit or Over-Load
		ON	Load On
		OFF	Load Off

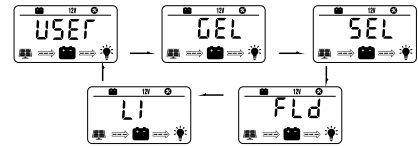

Abbreviations	Battery Types	Description
FLD	Flooded Battery	Auto-recognition with default parameters set for each type of batteries.
SEL	Sealed/AGM Battery	
GEL	Gel Battery	
LI	Lithium Battery	Some parameters can be customized.
Use	Advanced User Mode	Most parameters can be customized.

Advanced Battery Settings

In Lithium or User mode, short press the Setting key again to cycle through each parameter view.

Use the up and down arrow key to adjust parameter value, then long press Setting key to save.

For Battery Type: Li

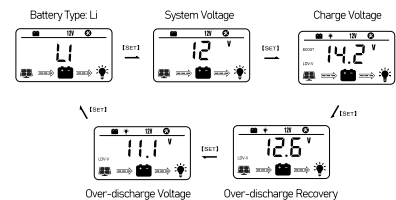

8. LCD Display Rules & Cycles

Pre start-up display cycle when the MPPT controller turns on, this usually last several seconds while controller detects operating environment.

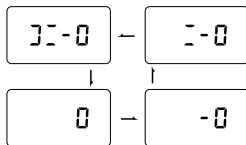

LCD Screen Display Cycle

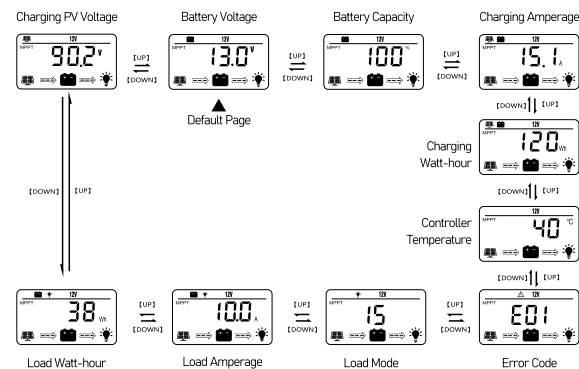

• The battery voltage view will be displayed by default. Use the up and down arrow keys to cycle through different views. The battery voltage view will resume upon 30 seconds of inactivity. The error code view will be displayed when an error is detected. The backlight in the screen will be on for 20 seconds with any button operation.

Setting Battery Mode

Enter SET mode by pressing the Setting key in any view page other than Load Mode. Use the up and down arrow keys to select battery mode, then long press Setting key to save.

For Battery Type: USER

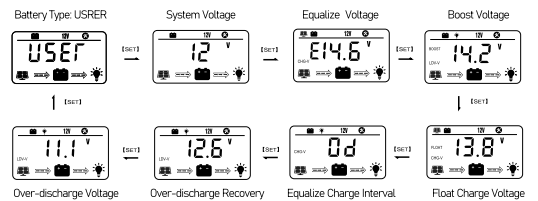

Load Mode Settings

Enter Load SET Mode by pressing the Setting key in Load Mode view only.

Use the arrow key to cycle through load modes before long pressing SET to save and exit.

Short pressing SET will exit without saving.

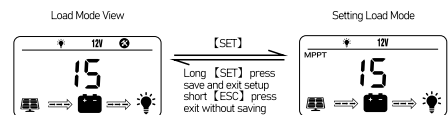

Mode	Definition	Description
0	Daylight Auto-Control	DC load turns on when daylight is detected.
1-14	Daylight On/Timer Off	DC load turns on when daylight is detected. DC load turns off according to timer.
15	Manual Mode	DC load turns on/off by pressing the Return key.
16	Testing Mode	DC load turns on and off in a quick succession.
17	Always On	DC load stays on.