

FEATURES

- Spectral region: 200-1100 nm.
- Spectral resolution: 0.01-4 nm.
- Linear low noise CMOS detector with 2048 pixel.
- Optical configuration: crossed C-T.
- Integration times: 2ms-130s.
- Supply voltage: DC 5V (USB Power).
- 18 bit (output 16 bit), 2MHz A/D Converter.
- Interface: USB2.0 or UART.
- 20-pin connector for interfacing to external products.

APPLICATIONS

- LED sorting machine
- Multi-parameter online water quality analyzer
- Micro-volume, fast spectrophotometer
- Fluorescence spectrometer
- Biochemical analyzer
- Transmittance and Reflectance detection
- LIBS

GENERAL DESCRIPTION

ATP2000P is the foundation of Optosky in ATP2000, a high-performance multi-purpose spectrometer using a number of breakthrough technologies was launched.

The CMOS detector exposure time can be controlled within 1ms, and customers can precisely control the signal-to-noise ratio of the spectrometer.

ATP2000P is an ideal choice for UV, visible, and near-infrared spectroscopy applications. It has different slits, gratings, mirrors, and filters to choose from. Spectrometer can be configured to suit different applications according to your needs. The spectral range starts from 200nm to 1100nm, spectral resolution can be selected from 0.5 to 4.0nm, Optosky can also provide customized options for OEM customers.

ATP2000P can receive the light to be measured from the SMA905 interface optical fiber input or free space input, measure according to the set integration time, and output the measurement results through USB2.0 (high speed) or UART.



1 Specifications

Detector	
Type	Linear array detector
Detectable range	200-1100 nm
Effective pixel	2048
Pixel dimension	14 μ m \times 200 μ m
Sensitivity	1300 V/(lx · s)
Dark noise	0.4V/RMS
Optical Parameter	
Wavelength range	200-400nm, 200-850nm, 200-1000 nm, etc. Different ranges can be customized
Optical resolution	0.1-4 nm (depends on the slit, spectral range)
Signal-to-noise	>2000:1
Dynamic range	10000:1
Optical Configuration	
Optical Design	F/4 crossed asymmetrical C-T
Focal Distance	40 mm for incidence / 60 mm for output
Incidence slit	5, 10, 25, 50, 100, 150, 200 μ m optional, other sizes can be customized
Incident Interface	SMA905 connector, free space
Electrical Parameter	
Integration time	0.1 ms - 130s
Interfaces	USB 2.0 or UART
A/D conversion resolution	18 bit (output 16 bit)
Supply voltage	DC4.5 to 5.5 V (type @5V)
Operating current	170mA@Typ.
Working temperature	0°C to +40°C
Working humidity	< 90%RH
Physics Parameter	
Dimension	102 \times 72 \times 34 mm
weight	0.2 kg

2 Mechanical Diagrams

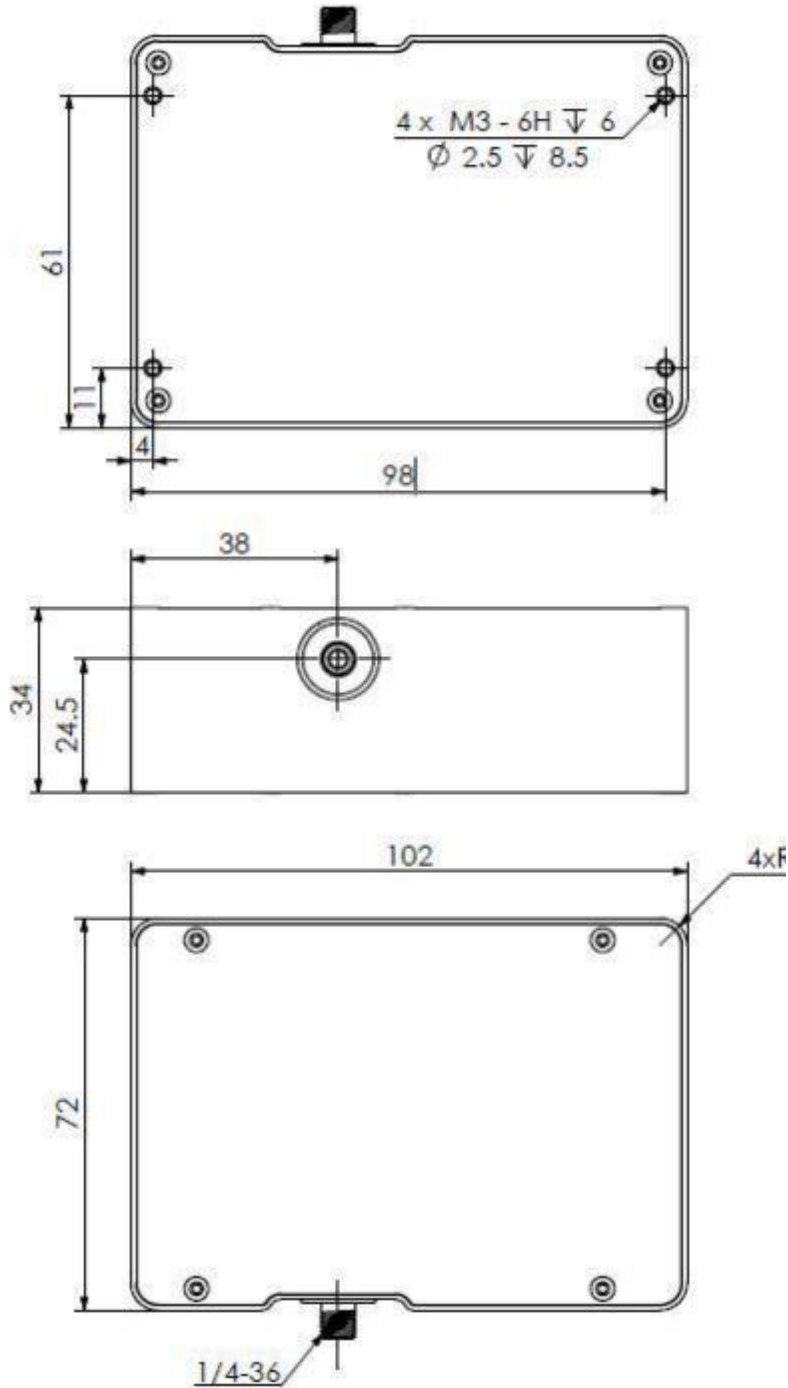

Mounting holes (M3×4)

SMA905 Female Fiber interface

The size of ATP2000 micro spectrometer

3 Measured spectrum

There is also the ATP2000H ultra-high-speed fiber spectrometer, whose spectral output frame rate can reach 1000fps. In addition, multiple functions are flexible and can be set up.

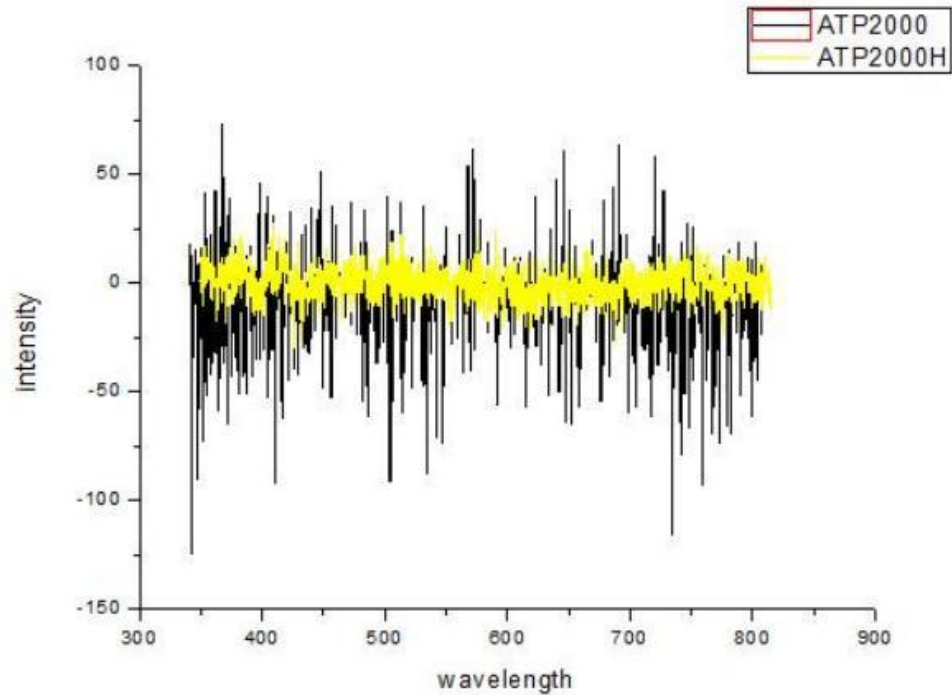

ATP2000P and ATP2000H test comparison chart.

4 Electrical Pin-out

Table 1 Electrical Characteristics

Parameter	Min	Typ	Max	Unit
Power Supply				
Operating voltage range	4.5	5	5.5	V
Operating current		170		mA
Logic Inputs(3.3V LVTTL, Five-volt tolerant)				
High level input voltage	1.7		3.6	V
Low level input voltage	-0.3		1.0	V
Logic Output(3.3V LVTTL)				
High level output voltage	2.4			V
Low level output voltage			0.4	V

The module is equipped with a 20-pin male angled box header(2x10, 2.00 mm pitch) and USB2.0 B type interface. The 20-pin connector is a Samtec part # STMM-110-02-L-D-RA connector. The mate to this is a Samtec part # TCSD-10-D-XX.XX-01-N.

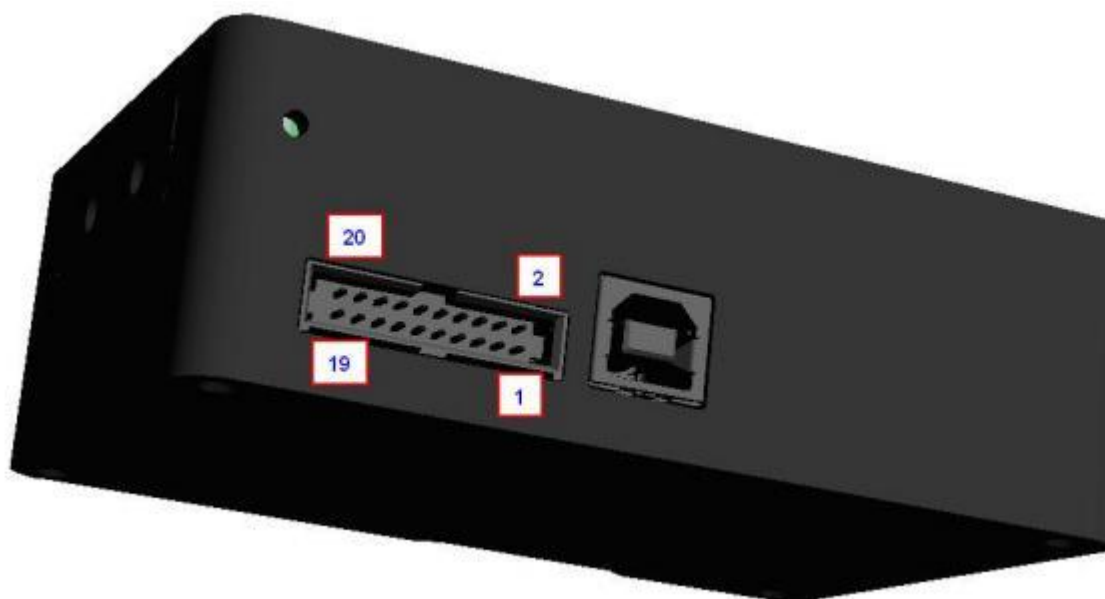

Table 2 Electrical Pin-Out

Pin#	Description	I/O	Function Description
1	VCC	/	Power Supply, 5V ±0.5,
2	GND	/	Ground
3	RS232_TX	Output	RS232 Transmit signal
4	RS232_RX	Input	RS232 Receive signal
5	Lamp_En	Output	LVTTL output the lamp enable signal.

6	Continuous_strobe	Output	LVTTTL output the continues strobe signal.
7	Ext_trigger_in	Input	LVTTTL input the trigger signal.
8	Single_strobe	Output	LVTTTL output the single strobe signal.
9	SPI_SCK	Output	The SPI Clock signal for communications to other SPI peripherals
10	SPI_MOSI	Output	The SPI Master Out Slave In (MOSI) signal for communications to other SPI peripherals
11	SPI_MISO	Input	The SPI Master In Slave Out (MISO) signal for communications to other SPI peripherals
12	SPI_CS	Output	The SPI Chip/Device Select signal for communications to other SPI peripherals
13	GPIO0	Input /Output	General Purpose Software Programmable Digital Inputs/Outputs, LVTTTL Logic.
14	GPIO1	Input /Output	General Purpose Software Programmable Digital Inputs/Outputs, LVTTTL Logic.
15	GPIO2	Input /Output	General Purpose Software Programmable Digital Inputs/Outputs, LVTTTL Logic.
16	GPIO3	Input /Output	General Purpose Software Programmable Digital Inputs/Outputs, LVTTTL Logic.
17	GPIO4	Input /Output	General Purpose Software Programmable Digital Inputs/Outputs, LVTTTL Logic.
18	GPIO5	Input /Output	General Purpose Software Programmable Digital Inputs/Outputs, LVTTTL Logic.
19	GPIO6	Input /Output	General Purpose Software Programmable Digital Inputs/Outputs, LVTTTL Logic.
20	GPIO7	Input /Output	General Purpose Software Programmable Digital Inputs/Outputs, LVTTTL Logic.

5 Order Guide

Order number Rules:

Model	Spectral region		Slit width
ATP2000P	Short wavelength	Long wavelength	Slit width

For example:

What to buy ATP2000P, spectral region: 200-850nm, slit width is 50 um, then the order no is:

ATP2000P-200-850-050

Order No	Spectral region	Slit
ATP2000P-200-400-###	200~400	10 μm
ATP2000P-200-850-###	200~850	25 μm
ATP2000P-200-1100-###	200~1000	50 μm

ATP2000P-340-850-###	340~850	100 μm	
ATP2000P-600-1100-###	600~1100	200 μm	
ATP2000P-###-###-###	Other	Other: _____μm	

6 Derivation

PN	Description
ATP2000	Basic type
ATP2000P	The high performance version
ATP2000H	High speed to 1Kpfs

7. Company Profile

Optosky company is a first-class spectroscopy solution provider, with the headquarter locates in the 7th floor of the research institute of the Chinese Academic of Science at an area of 2500 square meter in Xiamen city where successfully held the international 9th BRICK summit in 2017. The subsidiary company locates in Wuhu city with an area of 2035 square meters.

The company founder Dr. Hongfei, Liu graduated Doctor degree from the Chinese Academic of Science and postdoctoral degree from Xiamen University, by integrating both of top Universities' spectroscopy technology background into Optosky company aiming at developing the leading spectroscopy equipment in the world.

The company bases on unique technologies of Optomechatronics, Spectroscopy Analysis, Process Weak Optical and Electrical Signals, Cloud Computing, and have been developed wide products line of the competitive Raman spectroscopy instruments, micro spectrometer, hyperspectral imager, field spectroradiometer, fluorescence spectroscopy, LIBS etc. Driven by advanced technologies and products, Optosky brand has been well-known to customers all over the world.

Optosky company base on technology innovation, market-driven direction, customer first, provides first-class products and services, and one-stop solutions to many fortune 500 companies in many industries. The company received praise from different industry companies, as well as many innovative intellectual properties, software copyright, qualification certification, and winner awards over hundred numbers.

Optosky receives top class A introduced the high-tech company to international Xiamen city, the national high-tech and new innovative technology company award. The founder Dr. Hongfei Liu receives the innovation talent award by the ministry of science and technology.

The company is currently conducting the exclusive project of major industrialization national oceanic administration with a total fund of five million us dollars. The company in charge of drafting national industry standard of VNIR and SWNIR Field Spectroradiometer, and six national standard drafters, including China National Standard Drafter for Hazmat detector based on Raman spectroscopy, China National Standard Drafter for Buoy-type Monitor eco-environment, China National Standard Drafter for water quality monitor in the unmanned boat, China National Standards drafter for online water quality monitor by spectroscopy, China National Standard Drafter for UV-absorbent measure fabrics.

The company has over 70 IPs and over 20 innovative patents.

The company received ISO9001:2015 certification, CE certification, Police Administration Certification, FDA approval compliant, IQOQPQ compliant.



Figure 1 Optosky (Xiamen) Photonics Inc. Company Headquarter

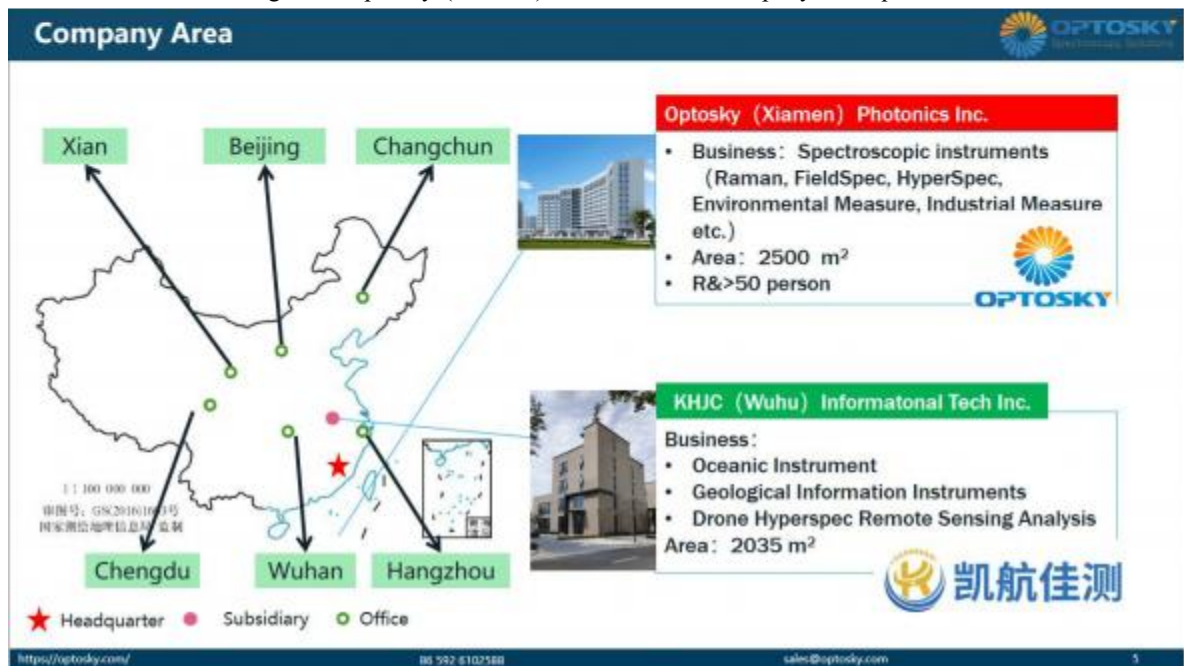

Figure 2 Optosky Company Area

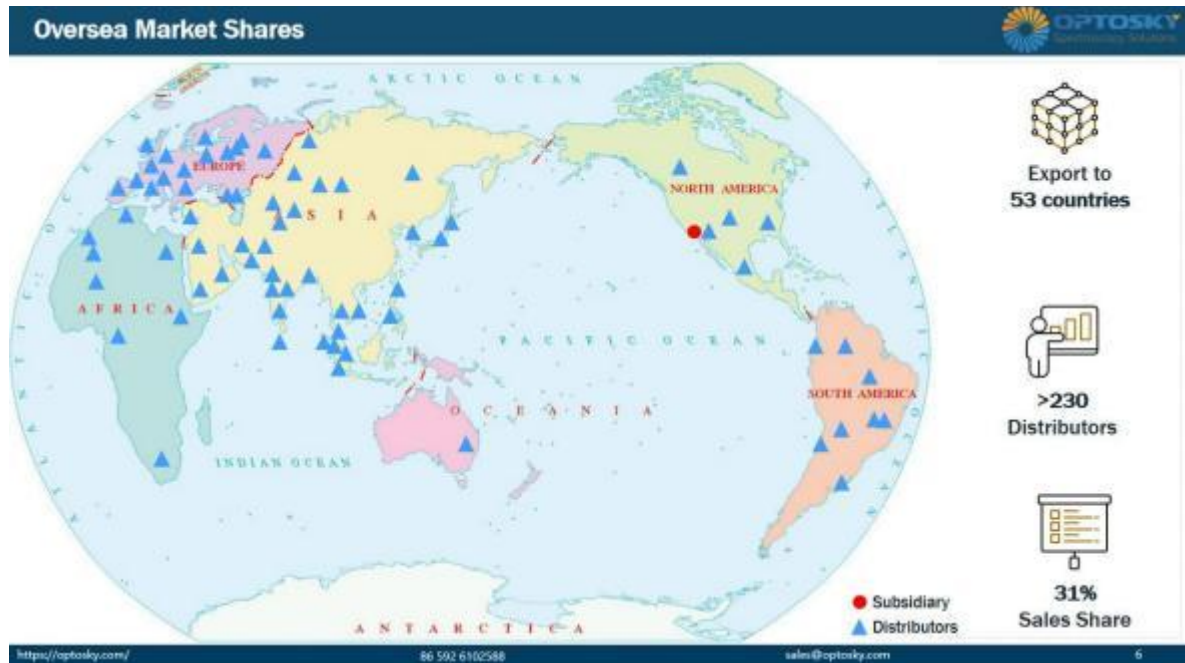

Figure 3 Oversea Market Shares



Figure 4 Optosky Chair and Draft National Standards Lists.

Qualification



 ISO9001:2005	 GB/T 23001 Informationization & Innovation	 CE, RoHS, LVD 17 models	 Police Approval 11 models
 GB/T 29490 IP implementation	 5 Innovative patents	 36 patents new utility design	 32 Software copyright

<http://optosky.com/>
86 592 6102588
sales@optosky.com
14

Figure 5 Qualification

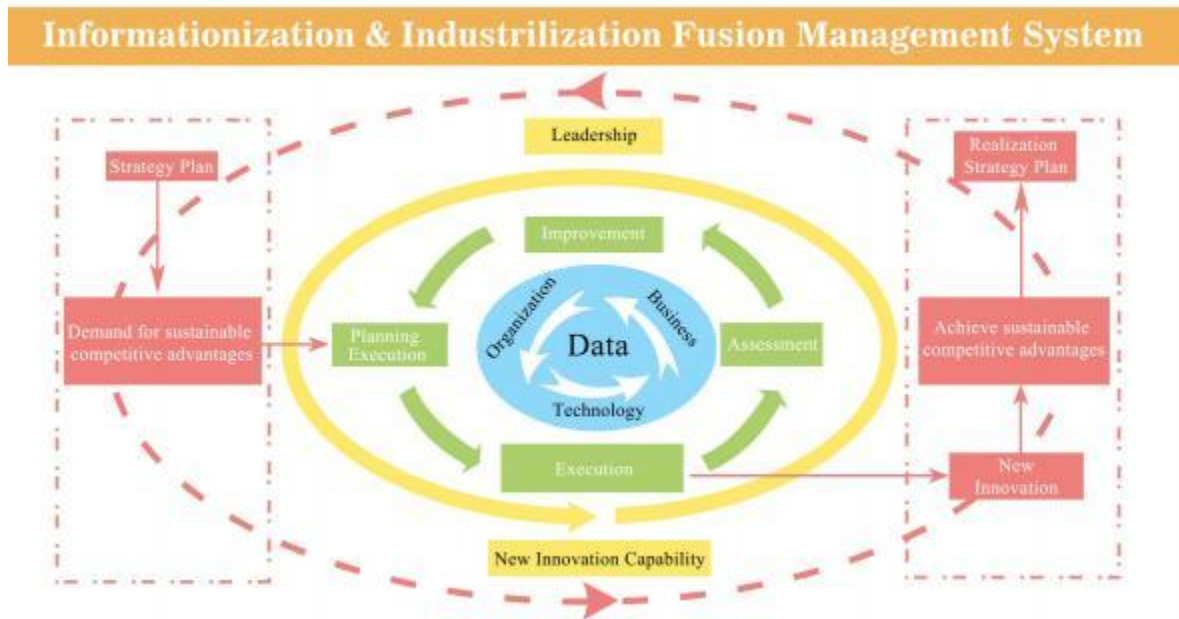

Figure 6 GB/T 23001_Informationization & Industrilization Fusion Management System

Co-Founder—Dr. Hongfei Liu



Postdoctoral Hongfei Liu

- Selected "Innovative Talent" by Science and Technology ministry
- Top Class A Talent by Xiamen City
- CCTV Science & Technology Interview
- Fortune 500 experience in Agilent, II-VI

- Honors**
 - Selected by science & technology ministry as "Innovation Talent"
 - CCTV Science & Technology Interview
 - Top Class A Talent credited by Xiamen City
 - Innovation Hero**
- Education**
 - PhD • Chinese Science of Academic • Prof. Gui-Lin Chen, Originator in spectroscopy
 - Postdoctoral • Xiamen University • Prof. Zhong-Qun Tian guided by the SERS founder M.Fleischmann
- Career**
 - Engineer → R&D Manager → GM
 - Agilent**, Leader of Instrument, Fortune 500 company, Job: engineer
 - II-VI Incorporated (Nasdaq: IIVI) leader in optical & electrical industries, Job: GM of Instrumentation and Automation
- Academic**
 - University graduate tutor
 - obtain more than 60 IPs, more than 10 innovation patents;
 - Publish more than 20 papers, 2 recorded SCI, 8 recorded EI



Selected "Innovative Talent" by Science and Technology ministry

Top Class A Talent by Xiamen City

Founder & Tutors

<http://optosky.com/>
86 592 6102588
sales@optosky.com

Figure 7 Optosky's Co-founder_Dr. Hongfei Liu

Category & Application

Category

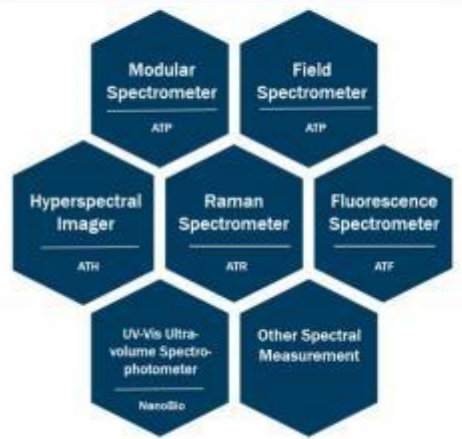

Application



<http://optosky.com/>
86 592 6102588
sales@optosky.com

Figure 8 Category & Application

Model Name Rule

Model Name Rule:

- Prefix
- Category
- Model
- Suffix

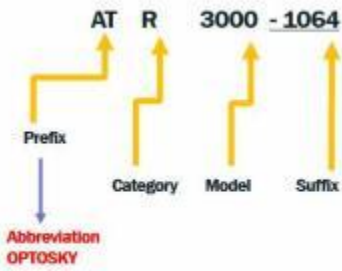

- **ATR** - Raman Spectrometer
- **ATP** - Micro Spectrometer
- **ATH** - Hyperspectral Imager
- **ATF** - Micro Fluorescence Spectrometer
- **ATL** - LIBS
- **ATW** - Water
- **ATE** - Environment Protect
- **ATFD** - Food Safety
- **GA** - Public Safety (Gong An)
- **GF** - Gas Monitor (Gas Finder)
- **GY** - Industrial Monitor (Gong Ye)

eg:

- Raman Microscope: ATR8300MP-1064
- Hyperspectral Imager: ATH9500

<https://optosky.com/>
86 592 6102588
sales@optosky.com
16

Figure 9 Model Name Rule